

-Weight as Shown: Approx. 5380Lbs.
 -Usage: 4-21" Slabs
 -Tooth: 9W8552
 Pin: 107-3378
 Retainer: 107-8559

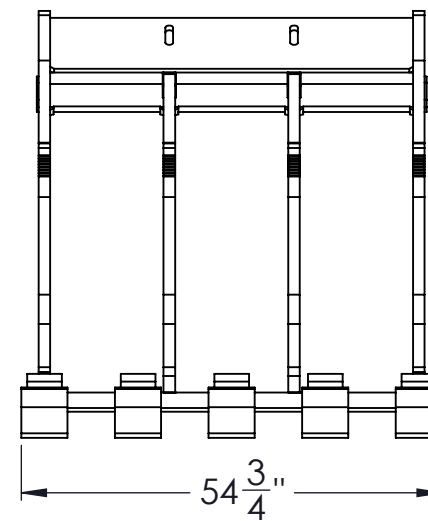

DRAWN BY:
 T. FREIDHOFF
 DATE:
 2/26/20

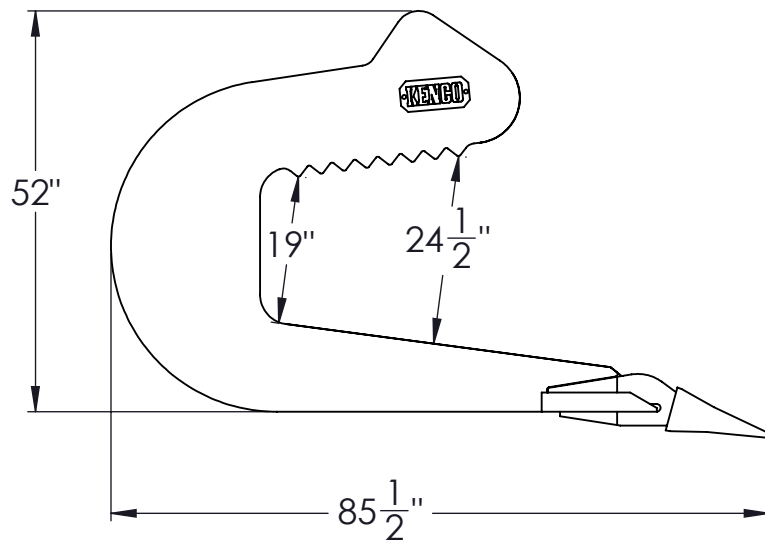

KENCO CORP.
 170 STATE ROUTE 271
 LIGONIER PA 15658
 (800)653-6069
 WWW.KENCO.COM
 THE INFORMATION PROVIDED WITHIN THIS DRAWING IS THE PROPERTY OF KENCO CORP. ANY REPRODUCTION, TRANSMITTAL, OR USAGE OF ANY KIND IS PROHIBITED WITHOUT WRITTEN PERMISSION.

DIMS. = IN.
 TOLERANCES:
 FRACT.: ±1/16
 ANG.: MACH±1°
 BEND ±1°
 DEC.: X.XX ±.03
 X.XXX ±.01

DESCRIPTION
 54SC400RT21
 Spec. Sheet

REVISION	
1	xxxxxx
DWG.	
5	